

# Envel PANEL SYSTEM PROMOTIONAL DETAILS

MANUFACTURER'S SPECIFICATION AND DETAILS SUBJECT TO CHANGE WITHOUT NOTICE



TITLE:

Envel PANEL SYSTEM S175

DRAWN BY:  
SS

DATE:  
4/11/16

REV.

SCALE:  
FULL

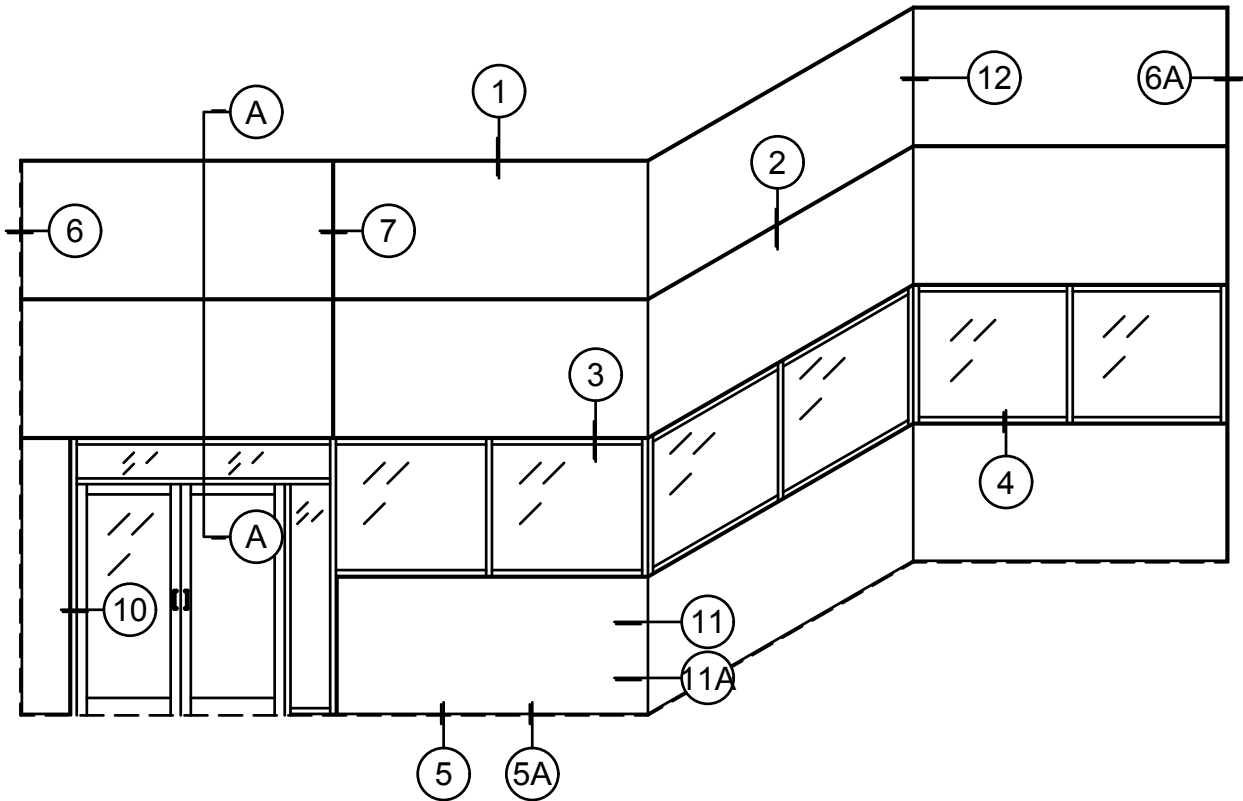

# ELEVATION

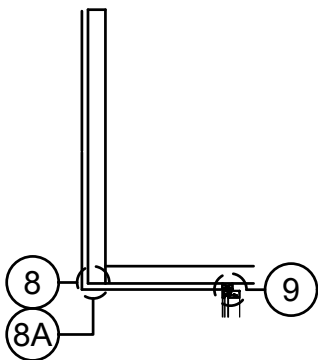

SECTION A-A



TITLE:

**Envel PANEL SYSTEM S175**

DRAWN BY:  
SS

DATE:  
4/11/16

REV.

SCALE:  
3/16" = 1'-0"

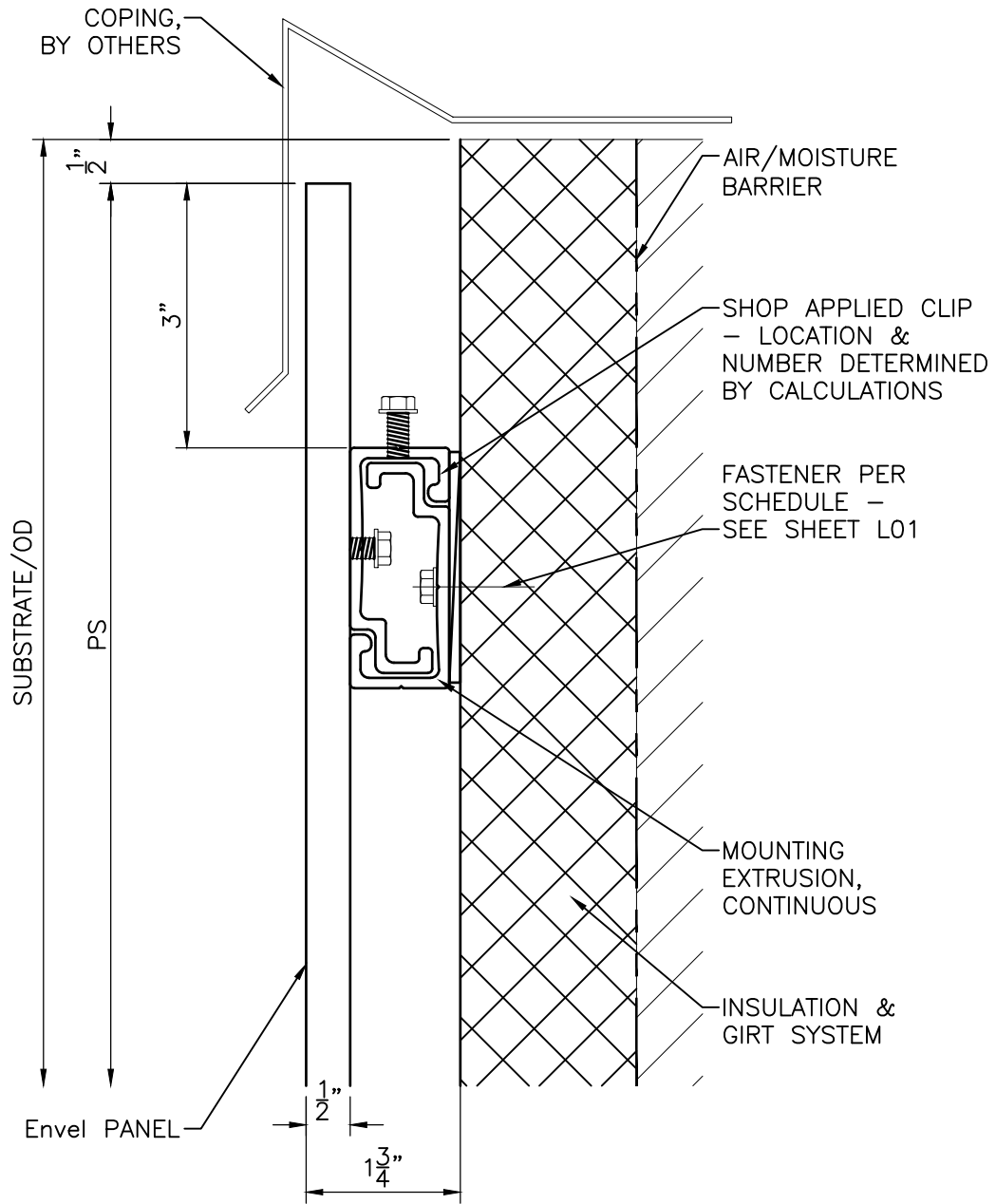

## TYPICAL UPPER TERMINATION



TITLE:

**Envel PANEL SYSTEM S175**

DRAWN BY:  
SS

DATE:  
4/11/16

REV.

SCALE:  
1:2

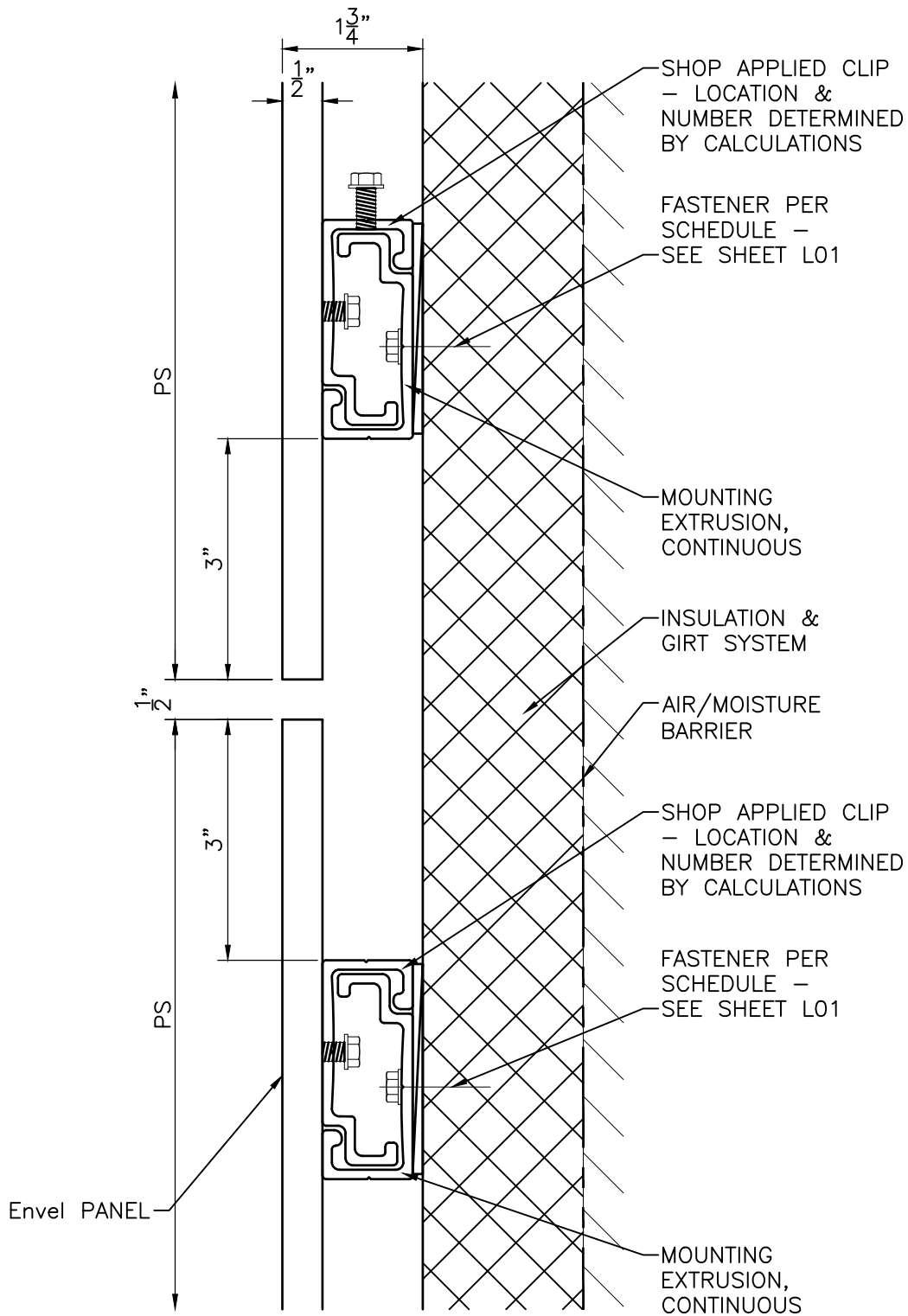

## TYPICAL HORIZONTAL JOINT



TITLE:

**Envel PANEL SYSTEM S175**

DRAWN BY:  
SS

DATE:  
4/11/16

REV.

SCALE:  
1:2

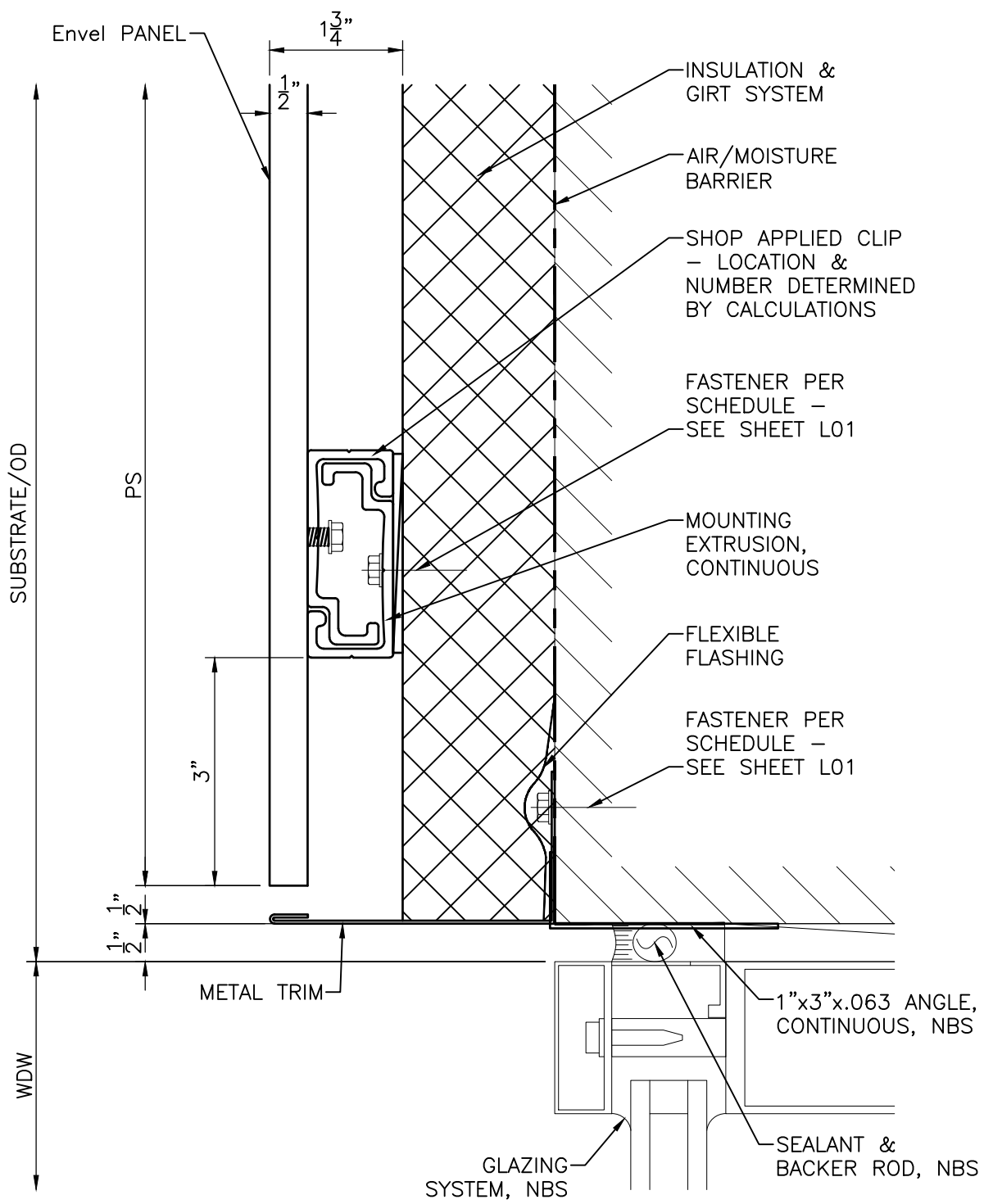

# TYPICAL GLAZING HEAD



TITLE:  
**Envel PANEL SYSTEM S175**

DRAWN BY: SS	DATE: 4/11/16	REV.	SCALE: 1:2
-----------------	------------------	------	---------------

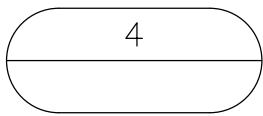
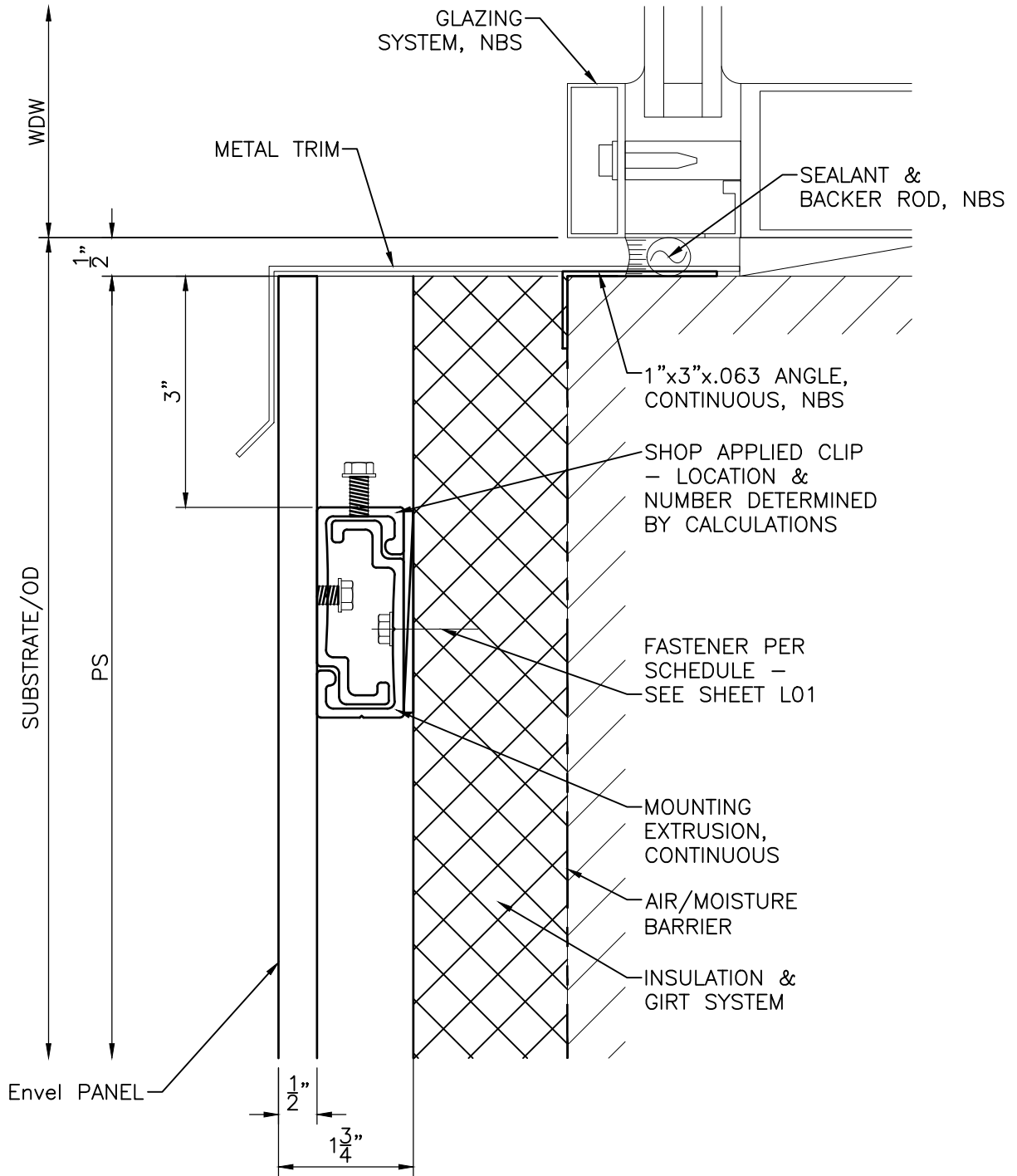

# TYPICAL GLAZING SILL



TITLE:  
**Envel PANEL SYSTEM S175**

DRAWN BY: SS	DATE: 4/11/16	REV.	SCALE: 1:2
-----------------	------------------	------	---------------

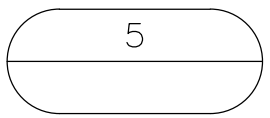
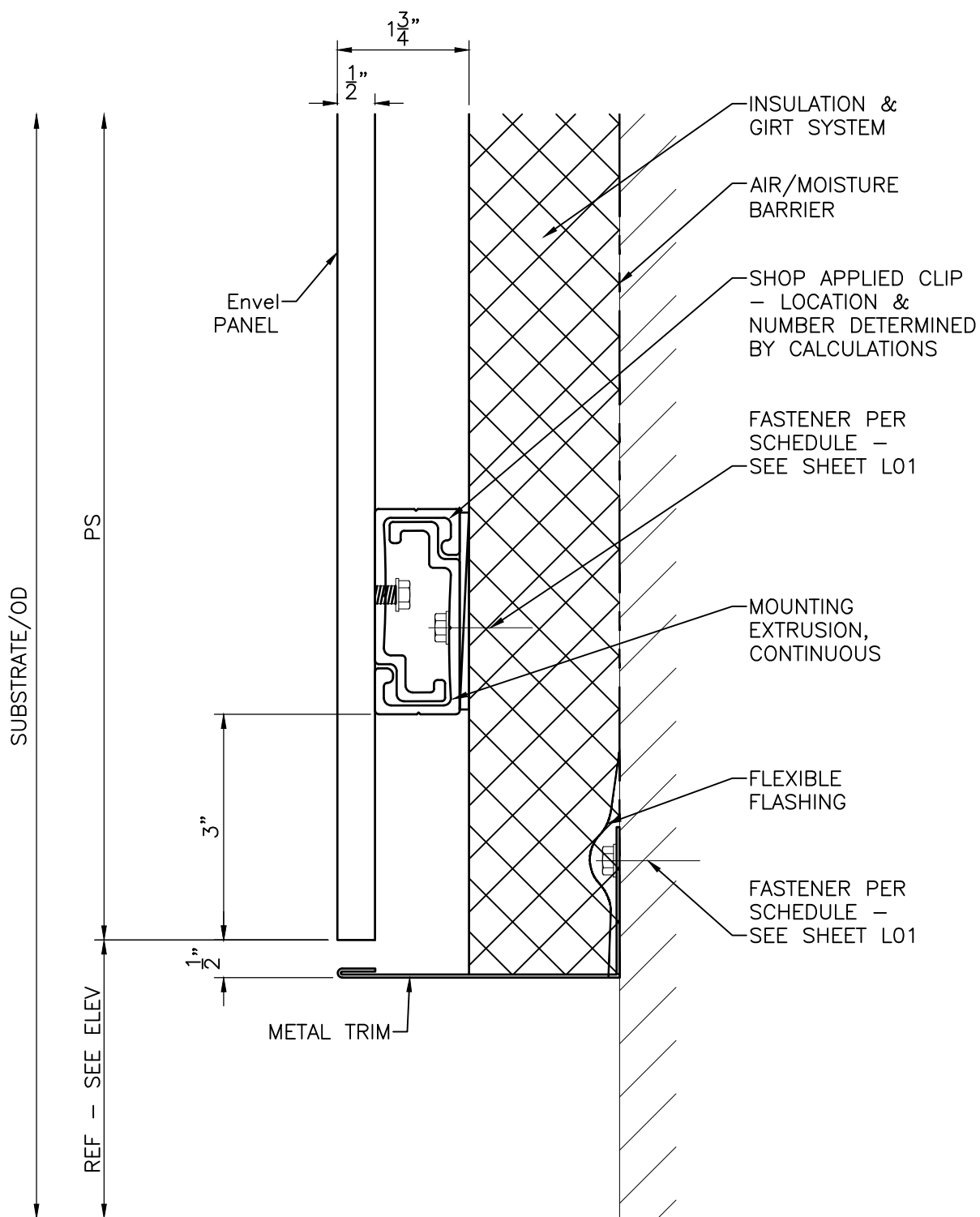

# TYPICAL SILL (EXPOSED)



TITLE:  
**Envel PANEL SYSTEM S175**

DRAWN BY: SS	DATE: 4/11/16	REV.	SCALE: 1:2
-----------------	------------------	------	---------------

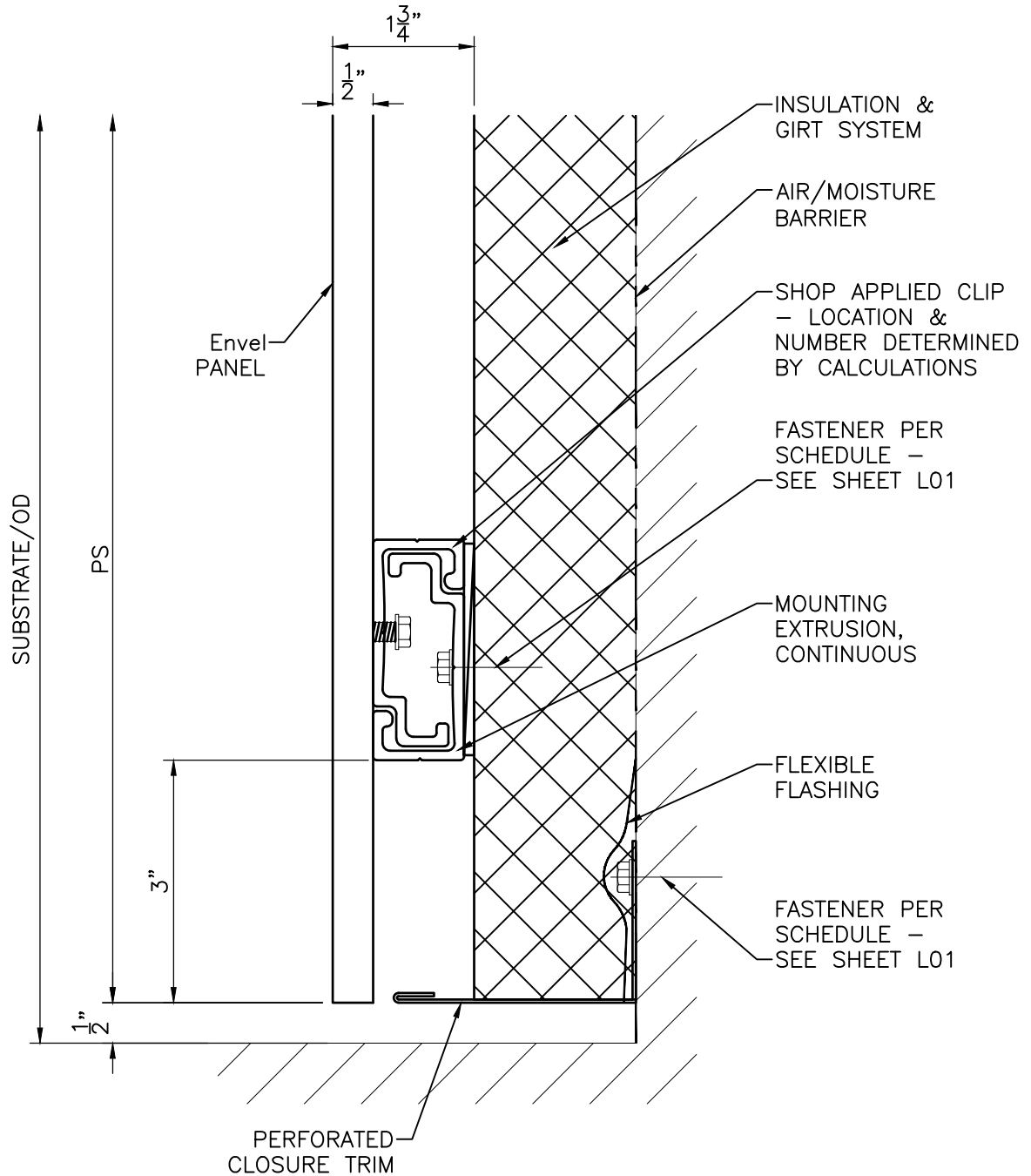

5A

# TYPICAL PANEL BASE



TITLE:

**Envel PANEL SYSTEM S175**

DRAWN BY:  
SS

DATE:  
4/11/16

REV.

SCALE:  
1:2



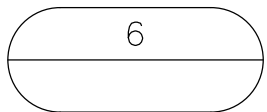
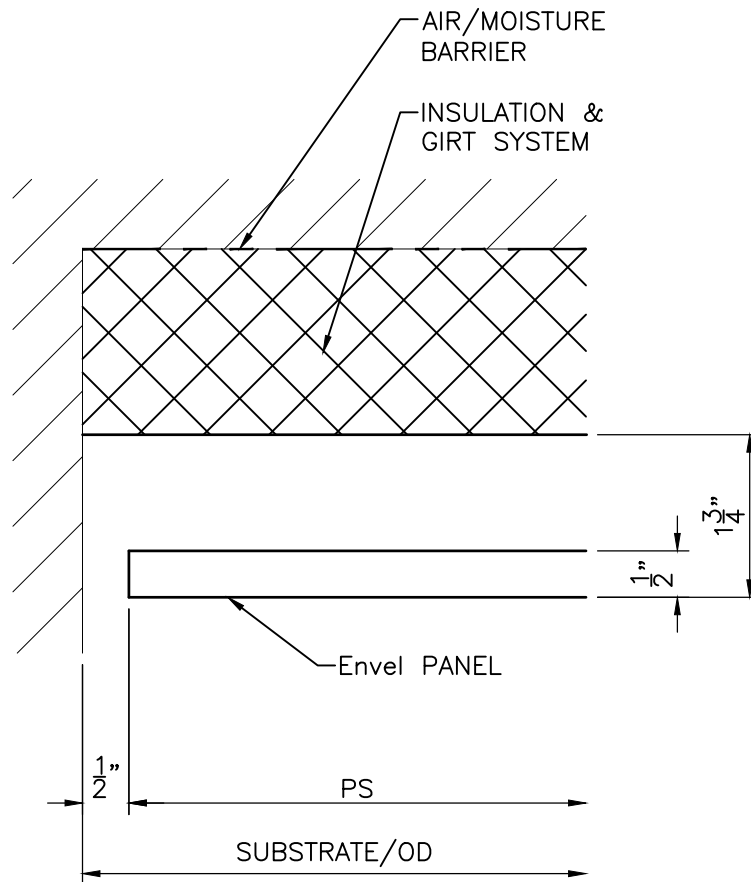

# JAMB TERMINATION



TITLE:  
**Envel PANEL SYSTEM S175**

DRAWN BY: SS	DATE: 4/11/16	REV.	SCALE: 1:2
-----------------	------------------	------	---------------

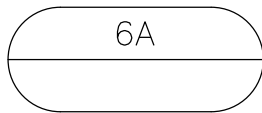
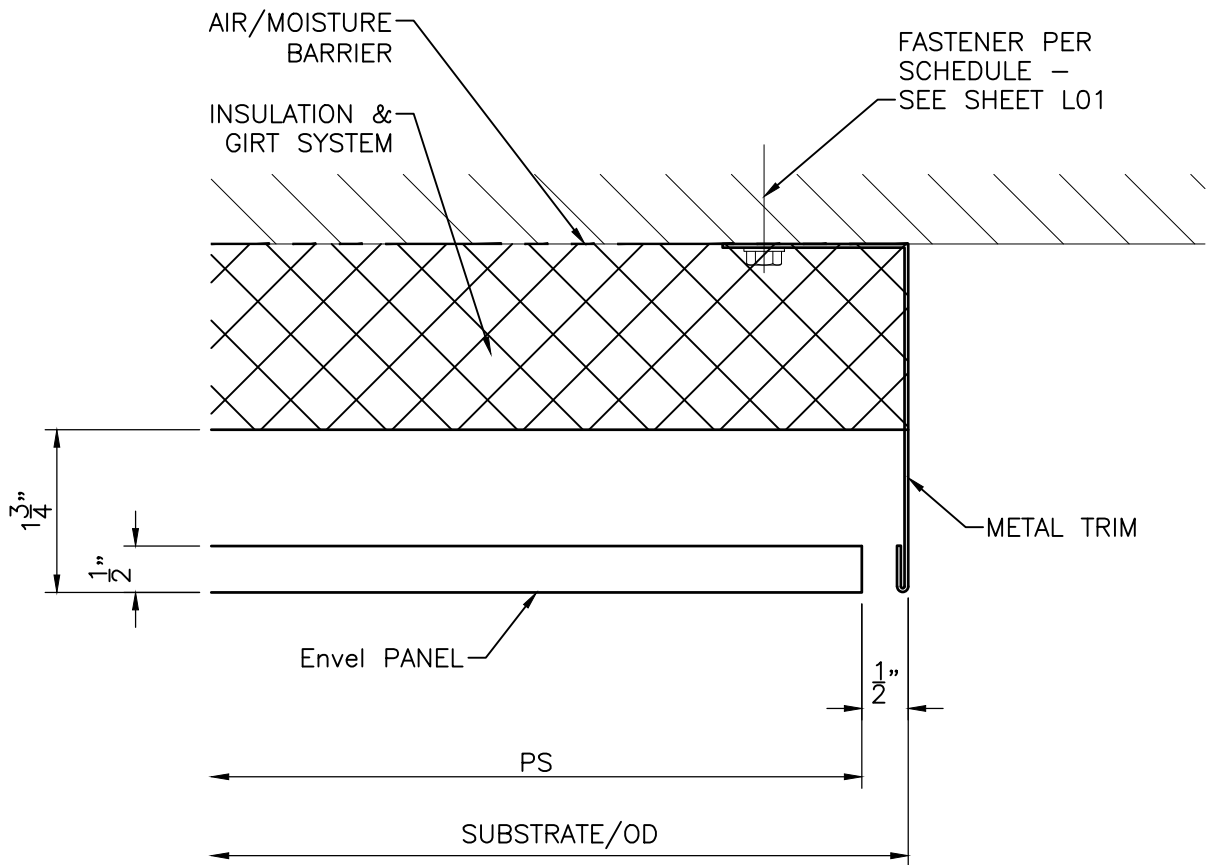

# JAMB TERMINATION



TITLE:

**Envel PANEL SYSTEM S175**

DRAWN BY:  
SS

DATE:  
4/11/16

REV.

SCALE:  
1:2

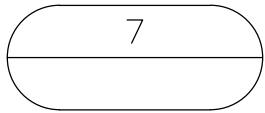
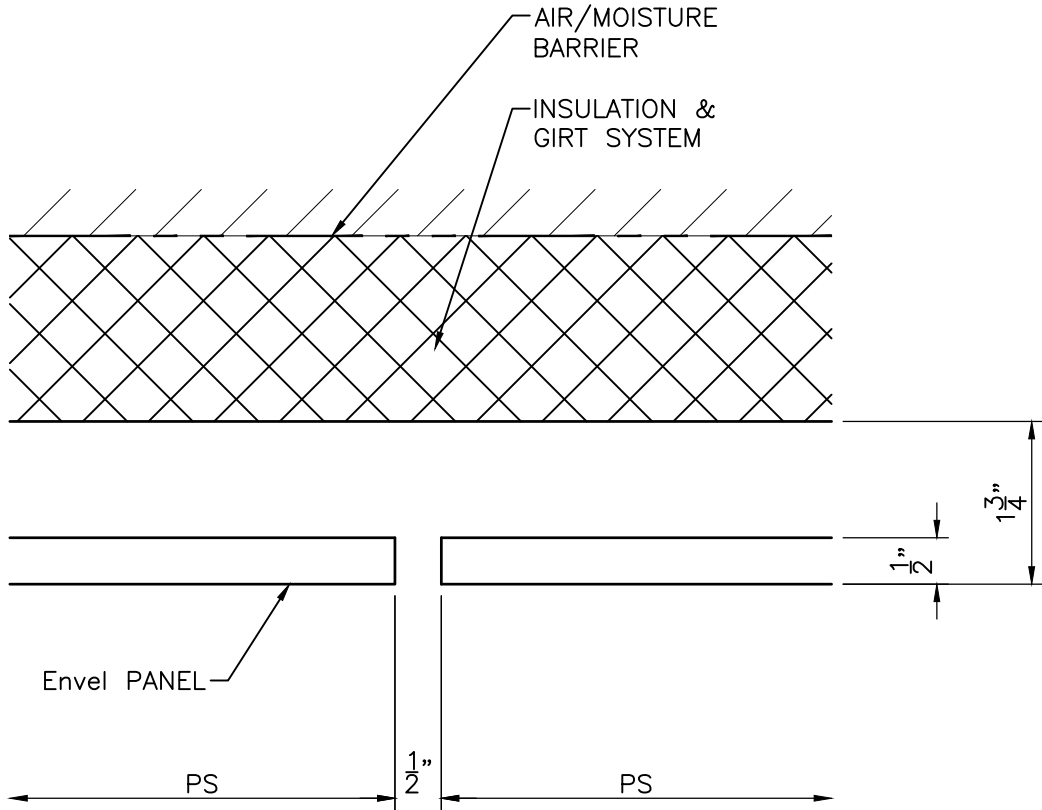

## VERTICAL JOINT



TITLE:

**Envel PANEL SYSTEM S175**

DRAWN BY:  
SS

DATE:  
4/11/16

REV.

SCALE:  
1:2

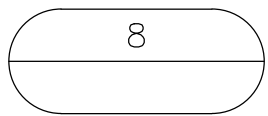
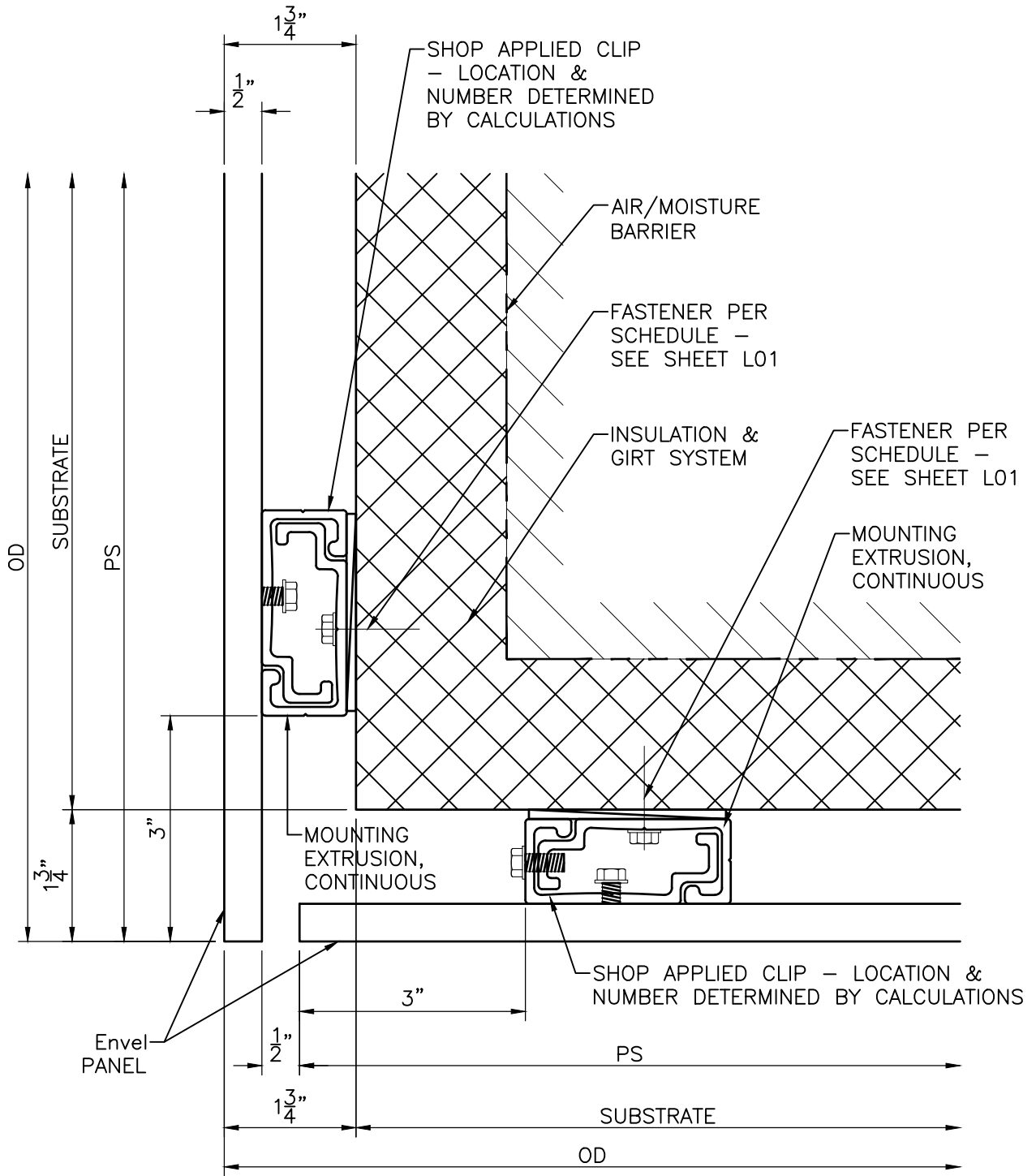

# SOFFIT RETURN



TITLE:  
**Envel PANEL SYSTEM S175**

DRAWN BY: SS	DATE: 4/11/16	REV.	SCALE: 1:2
-----------------	------------------	------	---------------

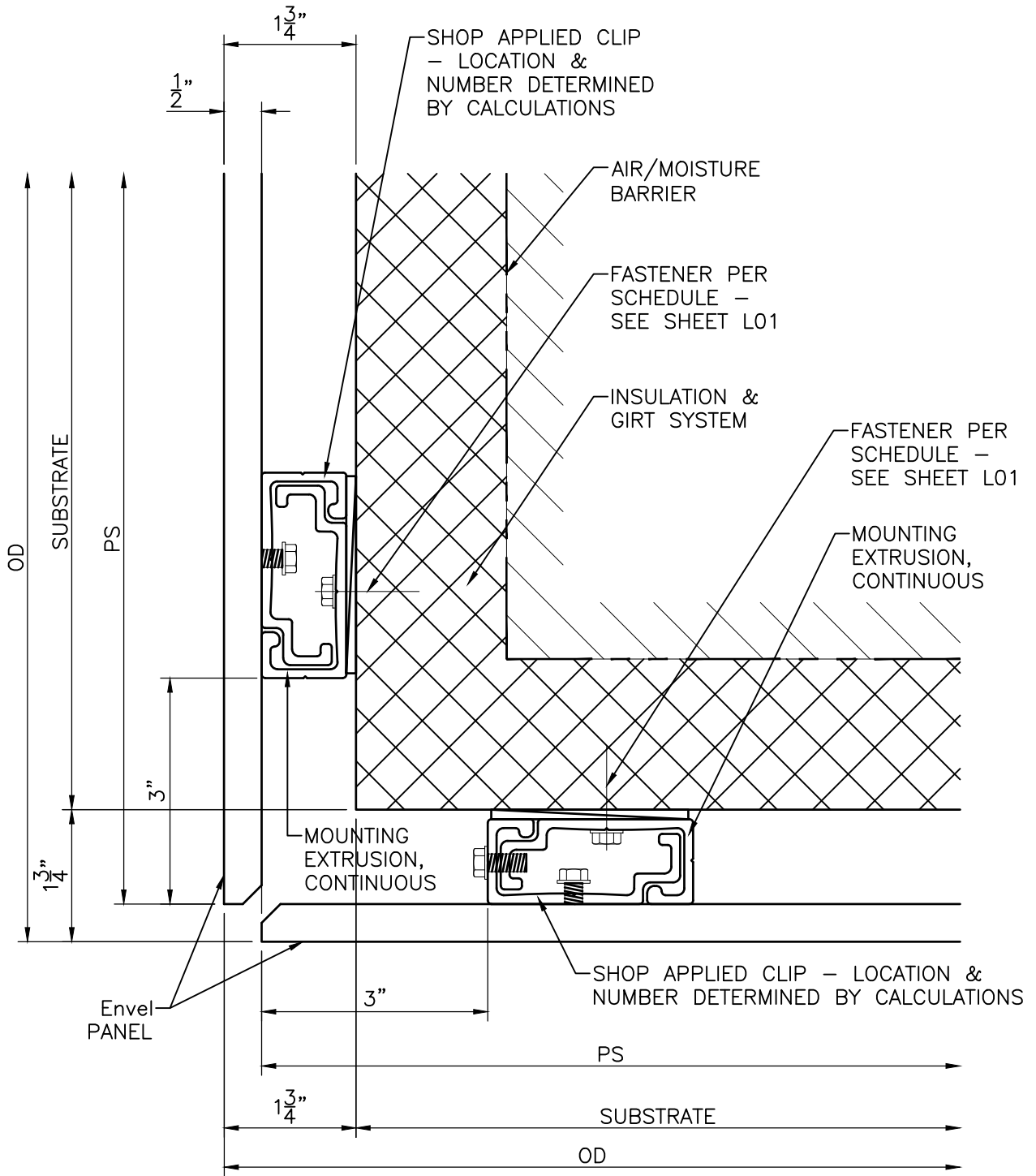

8A

# SOFFIT RETURN



TITLE:  
**Envel PANEL SYSTEM S175**

DRAWN BY: SS	DATE: 4/11/16	REV.	SCALE: 1:2
-----------------	------------------	------	---------------

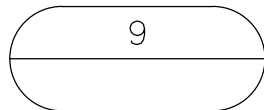
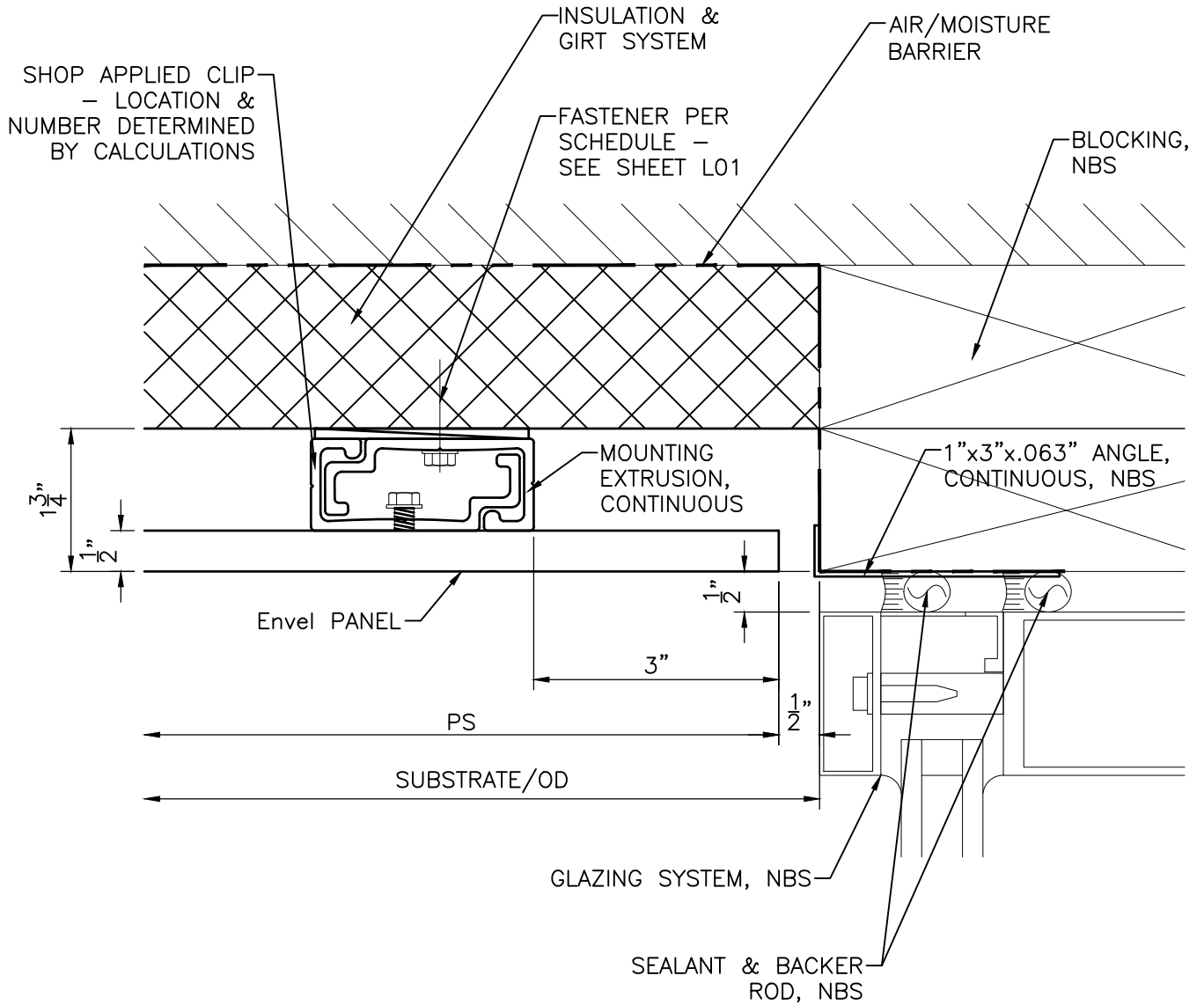

## SOFFIT RETURN TO GLAZING HEAD



TITLE:

**Envel PANEL SYSTEM S175**

DRAWN BY:  
SS

DATE:  
4/11/16

REV.

SCALE:  
1:2

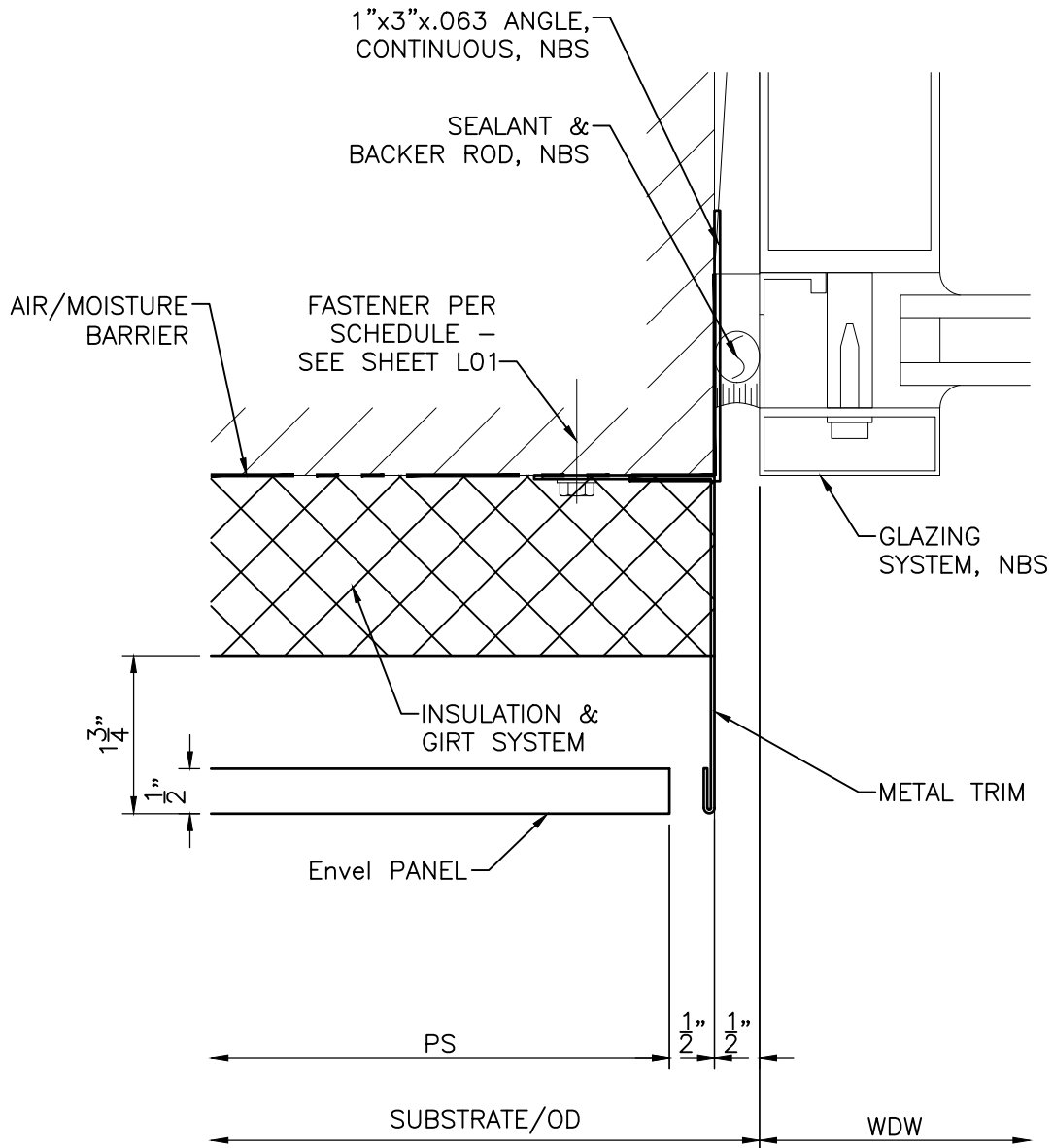

10

# TYPICAL GLAZING JAMB



TITLE:

**Envel PANEL SYSTEM S175**

DRAWN BY:  
SS

DATE:  
4/11/16

REV.

SCALE:  
1:2

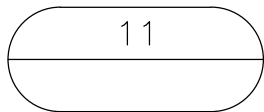
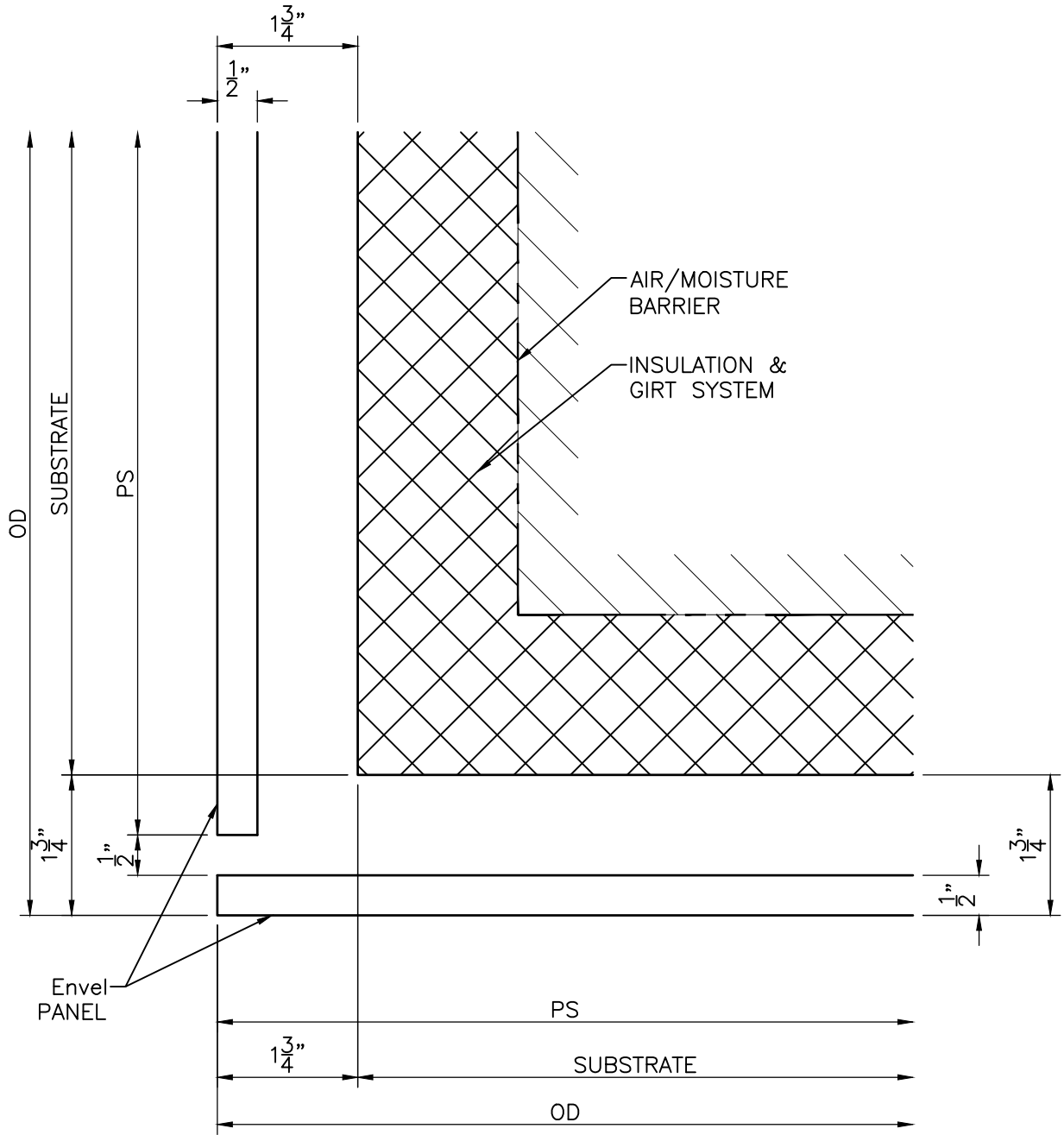

## OUTSIDE CORNER (PLAN VIEW)



TITLE:

**Envel PANEL SYSTEM S175**

DRAWN BY:  
SS

DATE:  
4/11/16

REV.

SCALE:  
1:2



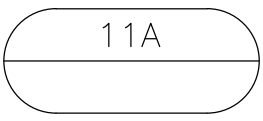
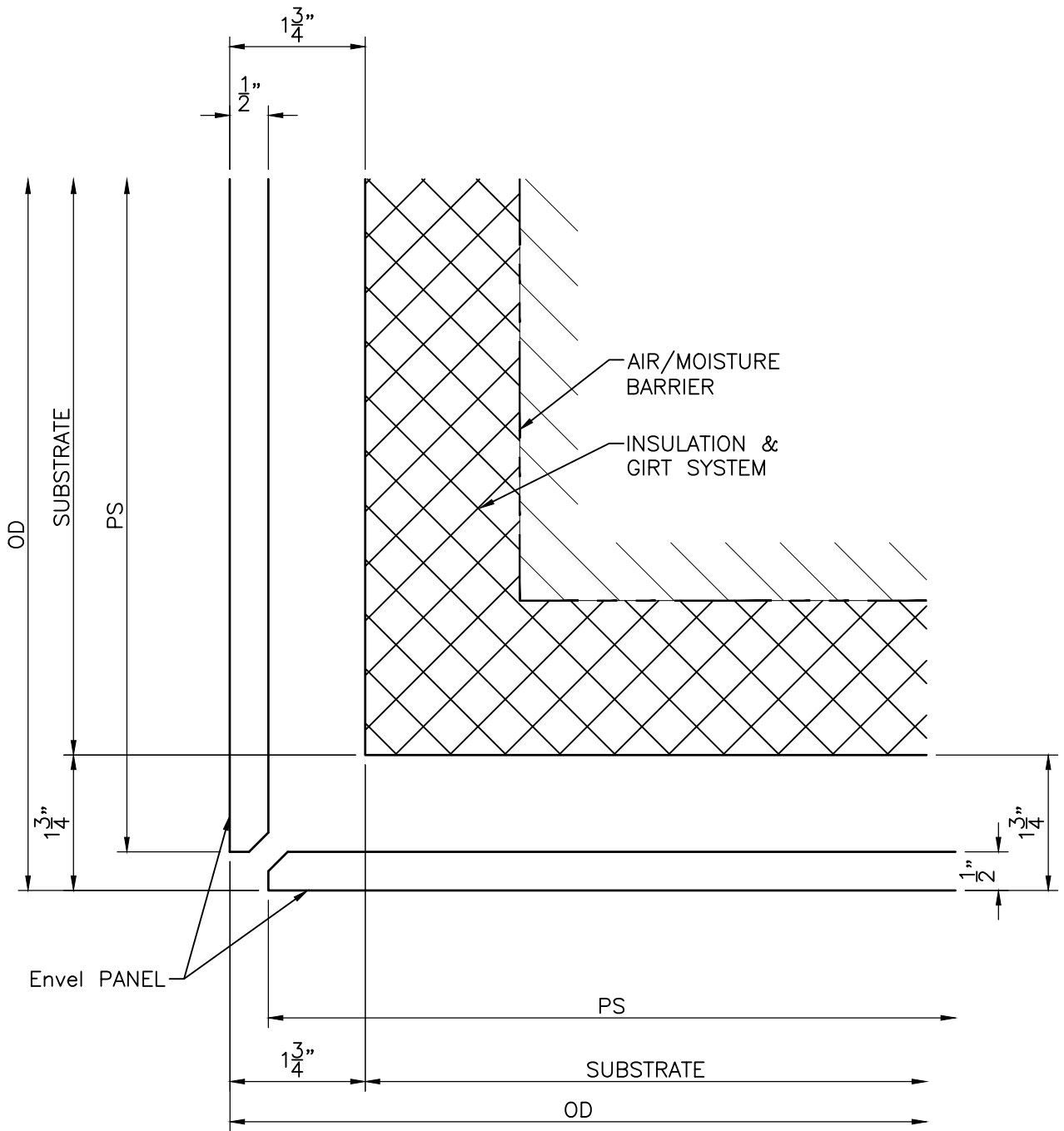

# OUTSIDE CORNER (PLAN VIEW)



TITLE:  
**Envel PANEL SYSTEM S175**

DRAWN BY: SS	DATE: 4/11/16	REV.	SCALE: 1:2
-----------------	------------------	------	---------------

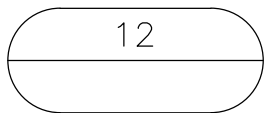
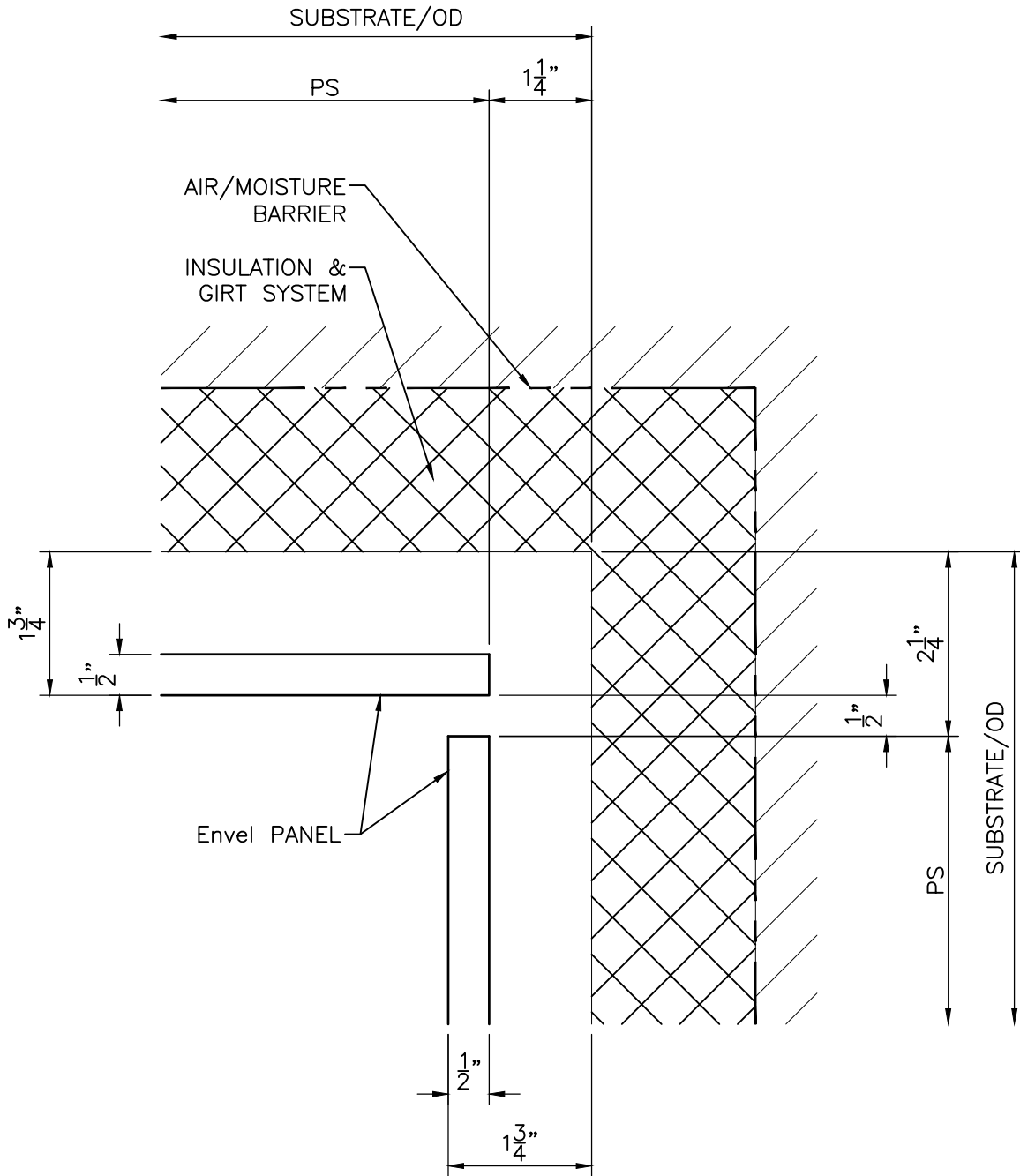

## INSIDE CORNER (PLAN VIEW)



TITLE:

**Envel PANEL SYSTEM S175**

DRAWN BY:  
SS

DATE:  
4/11/16

REV.

SCALE:  
1:2